

MATRIX
Single Phase Plugs – IP66



MATRIX 
**Australia
tough.**

MATRIX Single Phase Plugs – IP66

A comprehensive range of plugtops and cord extension sockets for single phase applications. All plugtops are rated to IP66 when matched to an IP66 socket, combination or cord extension socket.

Designed for the food industry, MATRIX plugtops allow superior hygiene standards to be maintained where they are most important. Clean product lines minimise areas where food or waste can build up.

The new small frame size MATRIX plugtops boast an M20 rear thread and standard external components, allowing cable connection flexibility and simplified maintenance.

MATRIX plugtops feature clear bodies, allowing for quick and easy inspection of the terminals, cord clamping and cable entry areas.

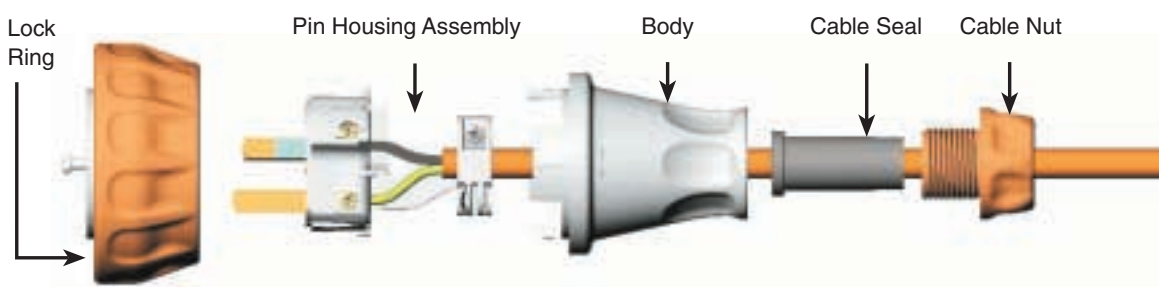

A Three Piece Design for Simplicity



- The locking ring is held captive on the plug front to create a single piece.
- The two assembly screws are also held captive in the front face of the plug.



- The pin assembly is designed to locate on the plug body to assist with assembly of the complete plug.
- All cable entries are in the rear of the pin assembly - no tortuous path needs to be negotiated.
- The cord clamp is hinged to swing out of the way during termination.
- The terminal screws are captivated to prevent them being lost during termination.
- Combination Pozi 1 / slotted screwhead.
- All terminals are clearly marked for easy identification and separated for electrical safety.
- We provide the certainty of a screwed cord clamp, with the convenience of a captivated single screw to tighten the clamp - the cord clamp is itself hinged on one side.



- The body is clear, for easy termination and cord clamp inspection.
- Assembly screws fix into threaded brass inserts for a secure assembly.
- The plug rear end features a standard M20 female thread for maximum versatility. This allows replacement of standard waterproofing components with alternatives, such as flexible conduit terminators.
- The rear water-proofing area consists of a two piece arrangement that is pushed up cable prior to termination - rubber grommet and threaded plastic compression nut.
- Two rubber grommet sizes to cover the range.

MATRIX Single Phase Plugs – IP66

Features



- IP66 rated
- Transparent body
- Designed for the food industry, Clean product lines minimise areas where food or waste can build up.
- M20 rear thread on small frame size plugtops, allowing flexibility in cable connection
- Small frame size plugtops all share the same external components, allowing for simplified maintenance stockholdings and minimised machine downtime when replacement products are needed
- All plugs feature the certainty of a cord clamp and the convenience of rear cable entry for terminals

MATRIX Straight and Angled Plugs – IP66

Cat No.	Ue V	In A	No. of Pins	Pin Config.	Cable Entry Diameter		Terminal Capacity		Price \$ Exc. GST
					Min (mm ²)	Max (mm ²)	Min (mm ²)	Max (mm ²)	
Straight									
MP210	250	10	2	a	6	12.5	0.75	1.5	29.56
MP215/32	32	15	2	b	6	12.5	1	2.5	34.90
MP310	250	10	3	c	6	9	0.75	1.5	20.25
MP310LS	250	10	3	d	6	12.5	0.75	1.5	29.95
MP310RP	250	10	3	e	6	12.5	0.75	1.5	30.33
MP310X	110	10	3	f	6	12.5	0.75	1.5	29.94
MP315	250	15	3	g	6	12.5	1	2.5	25.71
MP320	250	20	3	h	7	16	1	6	66.46
MP320F	250	20	3	i	8	12.5	1	2.5	34.14
MP332	250	32	3	j	10	27	2.5	16	102.99
Angled									
MPA320	250	20	3	h	7	16	1	6	65.01
MPA332	250	32	3	j	10	27	2.5	16	101.20

Socket Configurations

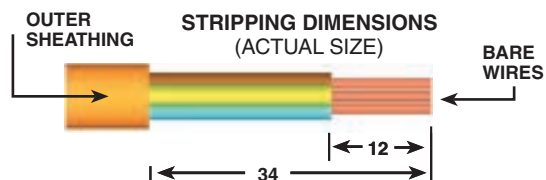
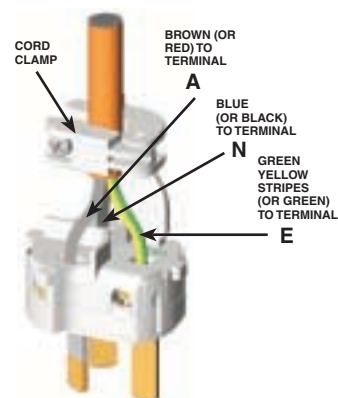
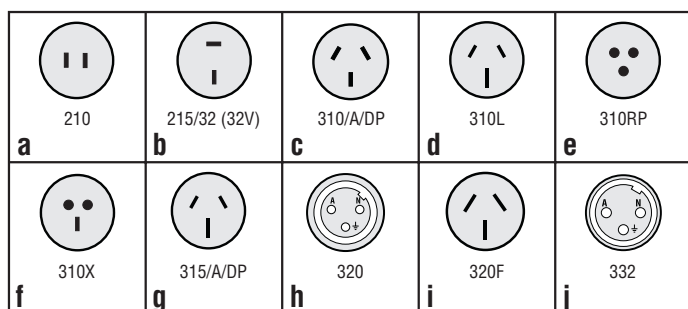

MATRIX Single Phase Plugs – IP66

MATRIX Single Phase Plugs Matching With...

MATRIX Single Phase Plugs		Socket Outlet	One Piece Switched Socket Outlets	Two Piece Switched Socket Outlets	Cord Extension Sockets	ROWCO Switched Socket Outlets
Straight	Angled					
MP210	-	MSO210	-	MC210	-	-
MP215/32	-	MSO215/32	-	MC215/32	-	-
MP310	-	MSO310	MCV310	MC310	MCSC310	RC310DPM
MP310LS	-	MSO310LS	-	MC310LS	-	RC310LSDPM
MP310RP	-	MSO310RP	-	MC310RP	-	-
MP310X	-	MSO310X	-	MC310XDP	-	RC310XDPM
MP315	-	MSO315	MCV315	MC315 (DP)	MCSC315	RC315DPM
MP320	MPA320	MSO320	MCV320DP	MC320DP	MCSC320	RC320DPM
MP320F	-	MSO320F	-	-	-	-
MP332	MPA332	MSO332	MCV332DP	MC332DP	MCSC332	RC332DPM

We recommend MATRIX Plugs for use of the entire MATRIX and ROWCO range to ensure the IP66 weather proof rating.

Dimensional Drawings

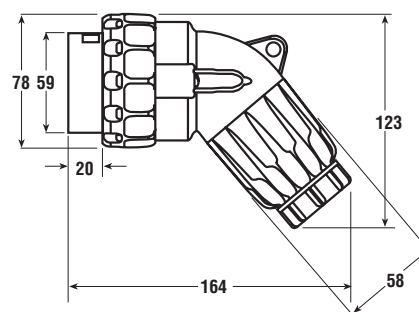
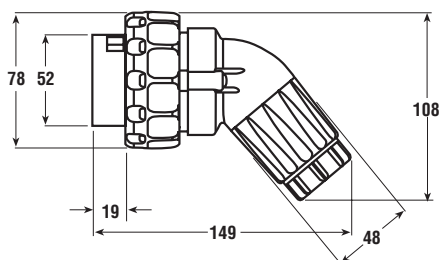
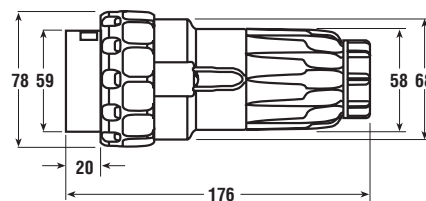
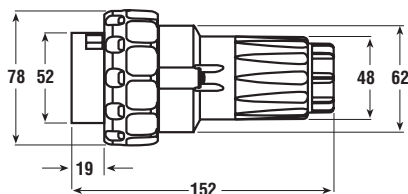
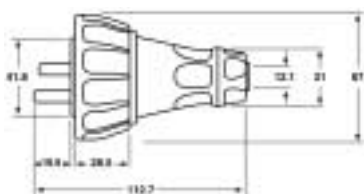

HELP CENTRE

Tel: 1300 369 233

Fax: 1300 369 288

Email: help@schneider.com.au

www.schneider-electric.com.au