

○ The modern art
of heating and
ventilation



HEATERS



Applications

PDL's innovative Thermosafe heaters are designed for domestic and commercial applications including family homes, apartments, hotels, motels, hostels, nursing homes, rest homes, schools and offices.

Features and benefits

- ✓ Easy to install with a unique internal plug and socket for two-stage installation.
- ✓ Flush mount and surface mount options.
- ✓ Designed for new installations as well as retrofits.
- ✓ Can be fitted to gip, plasterboard, concrete or brick walls.
- ✓ Compact, stylish range.
- ✓ Triple safety cut-out protection for Thermosafe heating.
- ✓ Axial fan ensures simple, reliable and quiet heater operation.
- ✓ Fan only setting allows the heater to operate as a cooling fan in summer.
- ✓ Easy to clean.
- ✓ Fitted with an air filter and supplied with a spare.
- ✓ Air filter is easy to remove for cleaning.
- ✓ Control panel is positioned under a cover so it won't invite unwanted attention.
- ✓ Selected models have a frost watch feature, thermostat delay, two-speed fan, audible alarm for blocked airflow, LED indicator for power on, blocked filter and 24-hour programmable rotary timer.

Care and cleaning

Thermosafe heaters are easy to clean with their smooth, round edges. Wiping with a damp cloth is recommended.

Abrasive detergents and spray-on cleaners should be avoided as they can damage the heater.

Dust or fluff in the heater can cause overheating and an unpleasant burning smell when the heater is turned on after a period of not being used. To remove dust, the air vents and front grille should be vacuum cleaned regularly.

The air filter requires cleaning at least once every three months and can be removed easily for this purpose.

Flush mount – new installations

Stage one: Flush mount heaters are supplied with a metal wall box which is fitted to framing studs. The special socket in the wall box can be terminated at the same time wiring is laid to flush boxes from the distribution board.

Stage two: The builder then puts up the wallboard, covering the wall box. Once a hole is cut for the heater and decoration is complete, the electrical contractor returns to take the heater out of its packaging and plug it into the pre-wired socket in the wall box. The heater is then screwed to the wall box and tested. Installation is complete.

A low profile flush surround is supplied with every flush mount Thermosafe heater as a decorative option.

Flush mount – retrofits

Stage one: A hole is cut for the wall box adjacent to a framing stud. Wiring is drawn through into the wall box prior to securing the box to the stud on one side. The wall box is then secured to the wallboard on at least one other side using the supplied clips. The special socket in the wall box can then be terminated.

Stage two: The heater is then plugged in and fitted to the wall box as above for testing.

Surface mount installation

PDL's Thermosafe surface mount heaters are supplied with a plastic wall box. Once the wall box is mounted to the wall and the internal socket terminated, the heater is plugged in and screwed to the wall box, ready for testing.

As with flush mount versions, installation is a quick and simple task.

Standards

PDL Thermosafe heaters have been tested to, and comply with, the following standards:

- AS/NZS 3350.2.30
- BS EN 55014
- IEC 60335.2.30
- CISPR 14
- BS EN 60335.2.30



Applications

PDL exhaust fans are designed for a range of domestic and commercial applications including:

- Kitchens
- Bathrooms
- Toilets
- Ensuites
- Living Rooms
- Bedrooms
- Laundries
- Garages
- Workshops

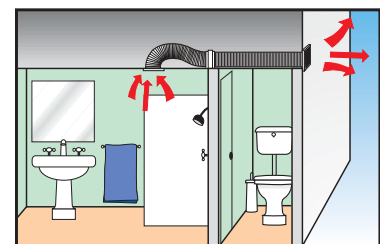
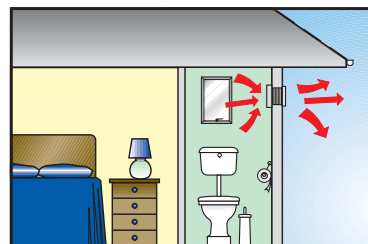
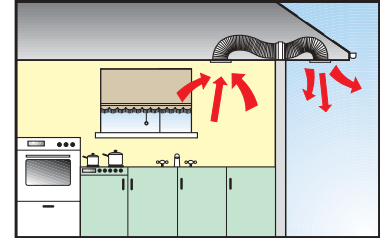
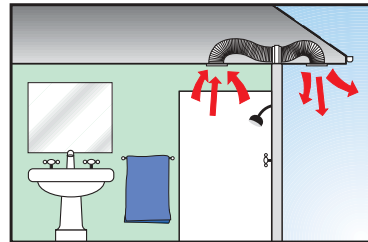

Features

- ✓ Stylish
- ✓ Easy to install
- ✓ Easy to clean and maintain
- ✓ Manufactured from thermal, shock-resistant plastic material for durability and maximum performance

Ducting

- ✓ Light weight
- ✓ Strong and flexible aluminium ducting for in-line and wall/ceiling fans
- ✓ Highly flexible PVC with spring steel helix wire for in-line fans
- ✓ Operates in temperatures from -5°C to 70°C

Motor

- ✓ Safety thermal fuse
- ✓ Easy installation
- ✓ Conforms to AS/NZS3350

Round in-line grilles

- ✓ Easy to remove
- ✓ Dishwasher safe or can be hand washed
- ✓ Grilles are angled to obscure the internal view of the duct and direct moist air away from the building
- ✓ Grille does not need to be oriented
- ✓ Grille is mounted with clamps for fast, easy installation. Using clamps prevents cracking from screw holes.



Poor ventilation produces stale air & condensation

Stale air

Musty, stagnant air can be caused by dampness, smoking, animals, cooking smells, odours remaining in damp bathrooms, or even just a lack of ventilation. Stale air produces an unpleasant environment and creates the risk of respiratory illness and general poor health.

Condensation

Condensation can cause widespread problems ranging from mould on carpets, curtains, and furniture, to peeling wallpaper, and even severe structural damage such as wood rot and damp.

Good ventilation for healthy living

PDL in-line and wall/ceiling exhaust fans provide simple solutions to domestic ventilation problems.

They are designed to create a healthy living environment through the controlled replacement of surrounding air.

The fans allow you to shut windows to keep valuable heat in and reduce drafts, while at the same time preventing condensation and stale air.

A good ventilation system also prevents costly maintenance expenses by preserving the life of the building.

INDEX

HEATERS

Bathroom heaters
Page 5



TOWEL RAILS

Towel rails
Page 5



Flush mount heaters
Page 6, 7



DIMENSIONAL DRAWINGS

Heating calculations
Page 8

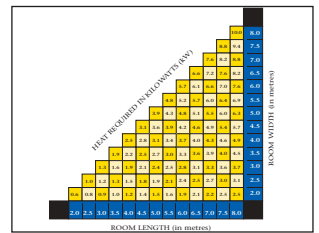

Heater dimensional drawings
Page 9

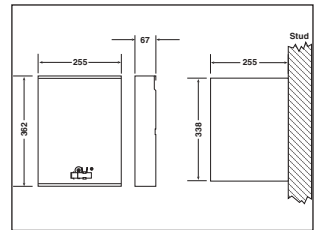

FANS

Exhaust fans
Page 10



Fan wiring diagrams
Page 11

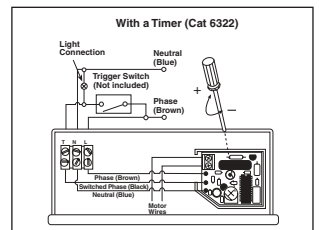

Fan accessories
Page 11



THERMOSAFE BATHROOM HEATERS



3208 bathroom heater

Bathrooms and ensuites can be heated quickly and efficiently by the compact 2.4kW heater.

For economy and comfort, the heater's automatic step-down thermostat reduces heat output to 1.2kW when the room reaches a pre-set temperature. Installation is made easier thanks to a new snap-fitting feature between the wall bracket and heater.



Cat 3208

Cat 3208

- 2.4kW heater
- Fan forced heating
- Two safety cut-outs for added protection.
- Automatic step-down thermostat reduces output to 1200 watts.
- Permanent installation required.
- 1 year warranty.

THERMOSAFE TOWEL RAILS



TSTR60 & TSTR80 towel rails

The two new models of Thermosafe heated towel rails provide a 60 watt option for either the smaller sized bathroom or ensuite as well as an 80 watt option for the family sized bathroom.

Both heated towel rails are rated IP34 splashproof and are double insulated for maximum safety protection.



Cat TSTR60

Cat TSTR60

- 1 heat setting – 60 watts
- Towel rails coated in scratch resistant enamel.
- Reversible mounting brackets for versatility in installation.
- Rated IP34 splashproof.
- Permanent installation required.
- 1 year warranty.

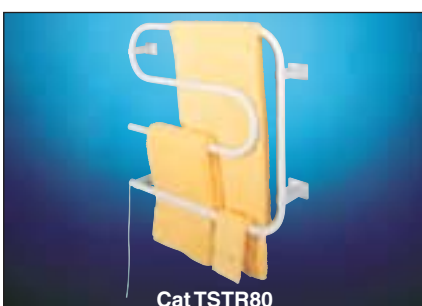

Cat TSTR80

Cat TSTR80

- 1 heat setting – 80 watts
- Towel rails coated in scratch resistant enamel.
- Reversible mounting brackets for versatility in installation.
- Rated IP34 splashproof.
- Permanent installation required.
- 1 year warranty.

FLUSH MOUNT HEATERS



Ratings

220V - 240V a.c.
9A
50Hz
1000/1100W - 2000/2200W

Available in white only.



Standard model

- Fitted with air filter and supplied with a spare.
- Can be wired with remote thermostat.
- Optional flush surround.

Cat 3303

- Four position rotary switch.
- Neon indicator for power available.
- Two heat settings: 1000W & 2000W.
- Fan only setting.
- Triple safety cut-out protection (two self-resetting element cut-outs plus thermal fuse).



Thermostat

- Fitted with air filter and supplied with a spare.
- Thermostat control.
- Frost watch (the heater switches on when the room temperature falls below approximately 5°C).
- Optional flush surround.

Cat 3304

- Four position rotary switch.
- Neon indicator for power available.
- Two heat settings: 1000W & 2000W.
- Fan only setting.
- Triple safety cut-out protection (two self-resetting element cut-outs plus thermal fuse).



Thermostat Plus

- Thermostat control.
- Thermostat delay (when thermostat switches off, fan continues to run quietly to remove residual heat for more accurate thermostat operation).
- Frost watch (the heater switches on when the room temperature falls below approximately 5°C).
- Audible alarm (alarm will sound to indicate a fault such as that the air flow is restricted at the inlet or outlet).
- Optional flush surround.

Cat 3305

- Four position rotary switch.
- LED indicator for power available, power on and blocked air filter.
- Two heat settings: 1000W & 2000W.
- Fan only setting.
- Two-speed fan (on low heat setting, the fan slows down for quieter operation and greater heat intensity).
- Triple safety cut-out protection (two non-self-resetting element cut-outs plus thermal fuse).
- Fitted with air filter and supplied with a spare.



Timer model

- Thermostat control.
- Thermostat delay (when thermostat switches off, fan continues to run quietly to remove residual heat for more accurate thermostat operation).
- Frost watch (the heater switches on when the room temperature falls below approximately 5°C).
- Audible alarm (alarm will sound to indicate a fault such as that the air flow is restricted at the inlet or outlet).
- 24-hour programmable rotary timer with AUTO/MANUAL/OFF switch.
- Optional flush surround.

Cat 3306

- Four position rotary switch.
- LED indicator for power available, power on and blocked air filter.
- Two heat settings: 1000W & 2000W.
- Fan only setting.
- Two-speed fan (on low heat setting, the fan slows down for quieter operation and greater heat intensity).
- Triple safety cut-out protection (two non-self-resetting element cut-outs plus thermal fuse).
- Fitted with air filter and supplied with a spare.

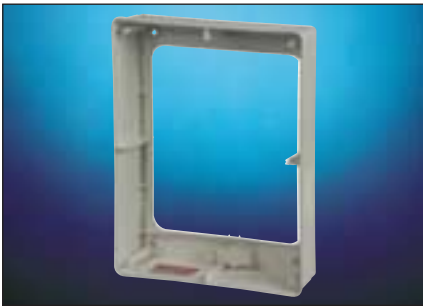

Surface mount kit

- Allows surface mounting of any flush mount model heater.

MOUNTING

GENERAL INSTRUCTIONS

- It is illegal for persons other than those authorised by legislation to work on the fixed wiring of any electrical installation.
- All installations must be in accordance with local and state Electrical Wiring Regulations and Building Codes of Practice.
- **DO NOT** locate heater immediately below a fixed socket outlet.
- The heater is to be installed so that the switches and other controls cannot be touched by a person in the bath or shower.

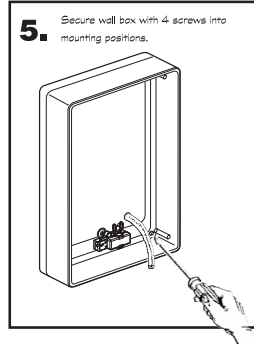
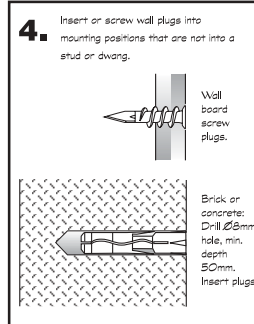
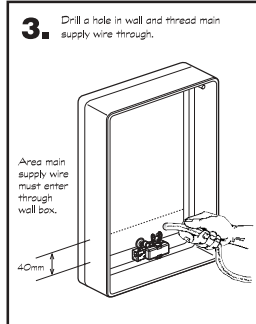
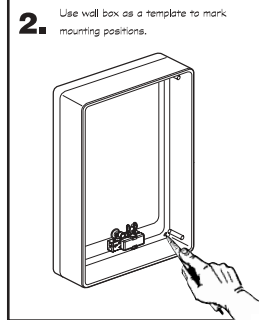
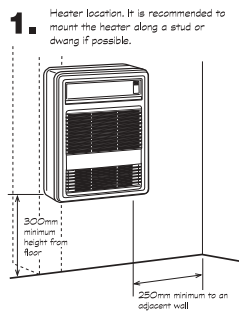

FITTING HEATER

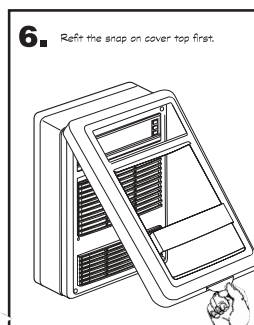
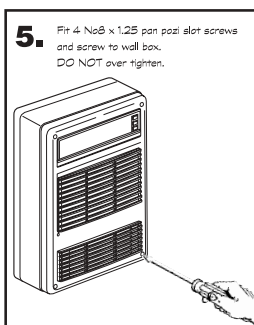
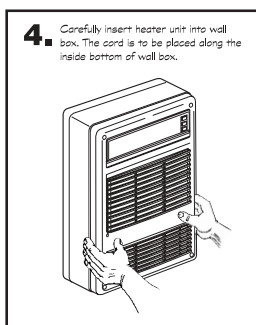
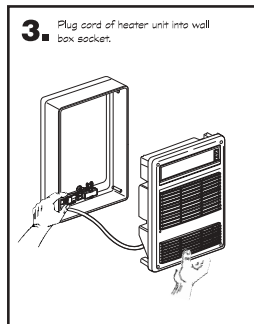
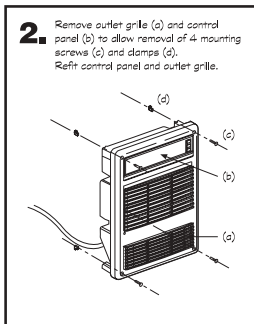
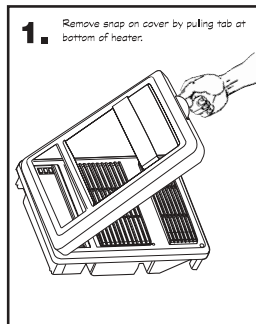

DIMENSIONAL DRAWINGS (in mm)

Flush mount heaters

Flush box size

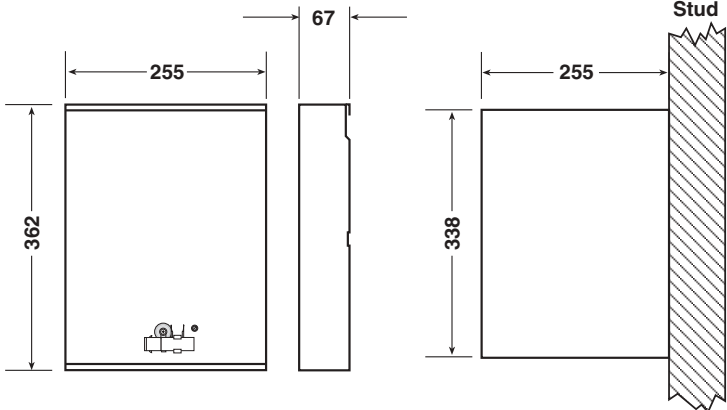

Recommended hole size for new installations

Cat 3303, 3304, 3305 and 3306 without flush surround

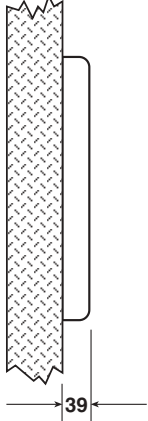
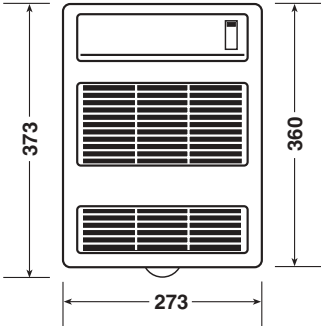

Cat 3303, 3304, 3305 and 3306 with flush surround

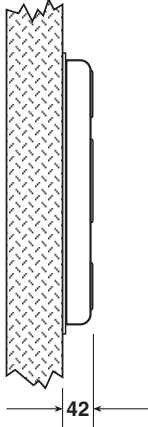
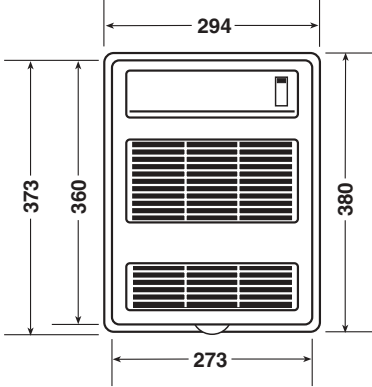

Surface mount heaters

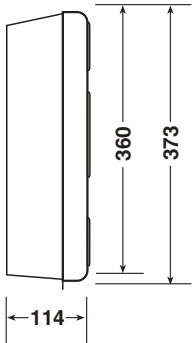
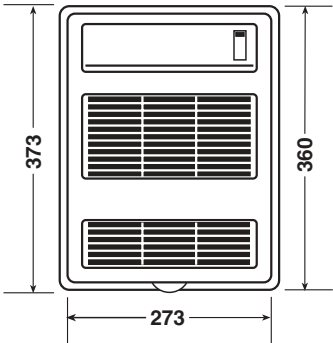

EXHAUST FANS



Exhaust fans

PDL in-line and wall/ceiling fans provide simple solutions to domestic and ventilation problems.

They are designed to create a healthy living environment through controlled replacement of surrounding air.

PDL fans are manufactured from thermal, shock-resistant plastic material for durability and maximum performance. Ideally suited for WC, kitchens, bathrooms and laundries.



6401, 6501, 6601

6401, 6501, 6601

Cat no	Duct	Nominal air displacement
6401	100mm/4"	85m ³ /hr
6501	120mm/5"	130m ³ /hr
6601	150mm/6"	230m ³ /hr

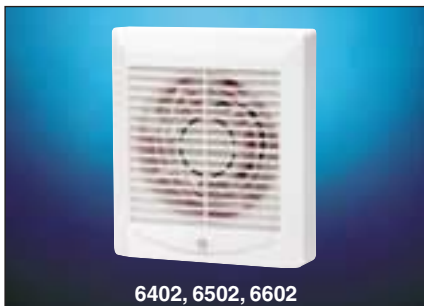

6402, 6502, 6602

6402, 6502, 6602

Cat no	Duct	Nominal air displacement
6402	100mm/4"	85m ³ /hr
6502	120mm/5"	130m ³ /hr
6602	150mm/6"	230m ³ /hr

Specifications

Cat no	6401/6402	6501/6502	6601/6602
Ducting diameter (mm/in)	100/4"	120/5"	150/6"
Duty at free discharge (m ³ /h)	85	130	230
Nominal air flow pressure (mmH ₂ O)	0.65	0.30	0.80
Max pressure (m ³ /h=0) (mmH ₂ O)	3.4	4.3	5.1
Voltage (at 50/60Hz)	230V	230V	230V
Power absorbed (W)	11	15	29
Sound pressure Level at 1.5m dB (A)	44	46	50
AS/NZS Standards	AS/NZS3350	AS/NZS3350	AS/NZS3350
Approvals	V41	V41	V41
Insulation class	II	II	II
IP Rating	IPX2	1PX2	IPX2
Max running temperature	40°C	40°C	40°C
Weight (kg)	0.62	0.77	1.08

Air flow diagram

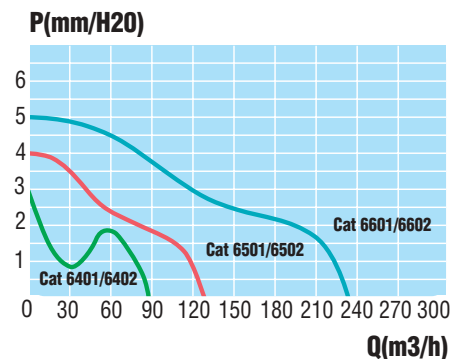



Through wall kits

For use with in-line or wall/ceiling fans to extract air away from the outside of the building.

Cat 6412

Includes 4" aluminium ducting (115mm compacted length and 320mm extended length), square grille surround, fixed grille, gravity louvres and mounting screws (4 x 4mm x 25mm long speed screws and 4 wall plugs).

Cat 6512

As for 6412 but with 5" aluminium ducting.

Cat 6612

As for 6412 but with 6" aluminium ducting.

Timers

Designed for efficiency and economy, timers prevent power wastage. Timers are fitted inside the fan; when the fan is switched off, it will continue running for the pre-set time to clear the air, then turn off automatically.

Cat 6312 (for in-line fans)

- Adjustable Time: From 3 to 20 minutes
- Max Load: 150W
- Voltage: 220 - 240V ~ 50 - 60Hz
- Weight: 30g
- Mounting: In foot of in-line fan motor.

Cat 6322 (for wall/ceiling fans)

- Adjustable Time: From 3 to 20 minutes
- Max Load: 150W
- Voltage: 220 - 240V ~ 50 - 60Hz
- Weight: 30g
- Mounting: In casing of wall/ceiling fan.

Wiring diagrams

In-line fans

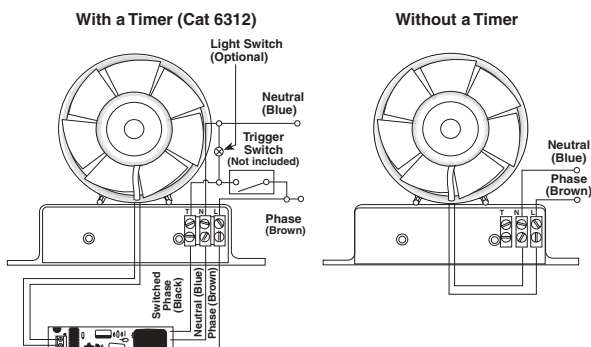

Wall/ceiling fans

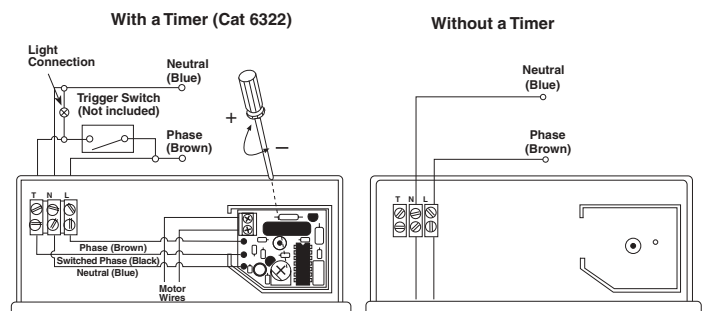



PDL products are privileged to reside in almost every New Zealand home and office. People touch PDL products millions of times across the country, every day.

PDL is also a significant exporter, earning foreign exchange for New Zealand by shipping industry-best value-added product around the globe.

The PDL Electrical Products range (largely made in Christchurch) offers an extensive range of switch and wiring accessories. The PDL Electronics range (made in Napier) involves high-tech electronic solutions for industrial applications.

In just over six decades, PDL has stamped its indelible hallmark of quality and innovation on the domestic, commercial and industrial markets in everything from electrical accessories to industrial switchgear, AC variable speed drives to home automation.

Plastic & Die Casting Ltd, founded in 1947 was purchased by the then Bob Stewart in 1957 and renamed PDL Industries Ltd. It was Sir Robertson Stewart's acumen which created the vehicle which allowed PDL to grow and thrive for the balance of the 20th century. PDL grew from 12 staff and sales of NZ\$5000 per annum, to 2000 staff and NZ\$350m sales across 3 continents – in 60 years.

Schneider Electric acquired the PDL Group in 2001. Schneider Electric's world-wide distribution network now offers the PDL brand to a wider global market.

PDL products continue to be designed and engineered by New Zealanders, from independent PDL manufacturing facilities in Christchurch and Napier. PDL is a Kiwi brand and we take genuine pride in that.

PDL is part of Schneider Electric's family of leading electrical brands. As with Merlin Gerin, Square D and Telemecanique – PDL products are marketed locally by Schneider Electric New Zealand.



PDL

PDL Electrical Products are available through electrical wholesalers New Zealand wide.

PDL Electrical Products are designed and engineered to ISO 9001.

Freecall: 0800 652 999, Freefax: 0800 101 152

Email: sales@nz.schneider-electric.com

Website: www.schneider-electric.co.nz

Schneider Electric (NZ) Ltd, Head Office

14 Charann Place, Avondale

PO Box 15355, New Lynn

Tel + 64 9 829 0490

Fax + 64 9 829 0491

Owing to changes in standards and equipment, the characteristics given in the text and images in this document are not binding until they have been confirmed with us.